

Frequency Synthesizer

KSN-860A-119+

50Ω 856.6 to 858.6 MHz

The Big Deal

- Low phase noise and spurious
- Robust design and construction
- Small size 0.80" x 0.58" x 0.15"



CASE STYLE: DK1042

Product Overview

The KSN-860A-119+ is a Frequency Synthesizer, designed to operate from 856.6 to 858.6 MHz for receiver application. The KSN-860A-119+ is packaged in a metal case (size of 0.80" x 0.58" x 0.15") to shield against unwanted signals and noise.

Key Features

Feature	Advantages
Low phase noise and spurious: <ul style="list-style-type: none">• Phase Noise: -101 dBc/Hz typ. @ 10 kHz offset• Comparison Spurious: -72 dBc typ.• Reference Spurious: -113 dBc typ.	Low phase noise and spurious improve system EVM (Error Vector Magnitude).
Robust design and construction	To enhance the robustness of KSN-860A-119+, each internal component is secured to the substrate with chip bonder, thereby eliminating the risk of tombstoning during subsequent solder reflow operations by the customer.
Small size, 0.80" x 0.58" x 0.15"	The small size enables the KSN-860A-119+ to be used in compact designs.



IF/RF MICROWAVE COMPONENTS • ISO 9001 ISO 14001 AS9100 CERTIFIED RoHS compliant
P.O. Box 350166, Brooklyn, New York 11235-0003 (718) 934-4500 Fax (718) 332-4661



The Design Engineers Search Engine finds the model you need, Instantly • For detailed performance specs & shopping online see



Notes: 1. Performance and quality attributes and conditions not expressly stated in this specification sheet are intended to be excluded and do not form a part of this specification sheet. 2. Electrical specifications and performance data contained herein are based on Mini-Circuit's applicable established test performance criteria and measurement instructions. 3. The parts covered by this specification sheet are subject to Mini-Circuits standard limited warranty and terms and conditions (collectively, "Standard Terms"); Purchasers of this part are entitled to the rights and benefits contained therein. For a full statement of the Standard Terms and the exclusive rights and remedies thereunder, please visit Mini-Circuits' website at www.minicircuits.com/MCLStore/terms.jsp.

Frequency Synthesizer

KSN-860A-119+

50Ω 856.6 to 858.6 MHz



CASE STYLE: DK1042
PRICE: \$29.95 ea. QTY (1-9)

+ RoHS compliant in accordance with EU Directive (2002/95/EC)

The +Suffix has been added in order to identify RoHS Compliance. See our web site for RoHS Compliance methodologies and qualifications.

Features

- Integrated VCO + PLL
- Low phase noise and spurious
- Robust design and construction
- Low operating voltage (VCC VCO=+5V, VCC PLL=+3.3V)
- Small size 0.80" x 0.58" x 0.15"

Applications

- Receiver

General Description

The KSN-860A-119+ is a Frequency Synthesizer, designed to operate from 856.6 to 858.6 MHz for receiver application. The KSN-860A-119+ is packaged in a metal case (size of 0.80" x 0.58" x 0.15") to shield against unwanted signals and noise. To enhance the robustness of KSN-860A-119+, each internal component is secured to the substrate with chip bonder, thereby eliminating the risk of tombstoning during subsequent solder reflow operations by the customer.

Simplified Schematic

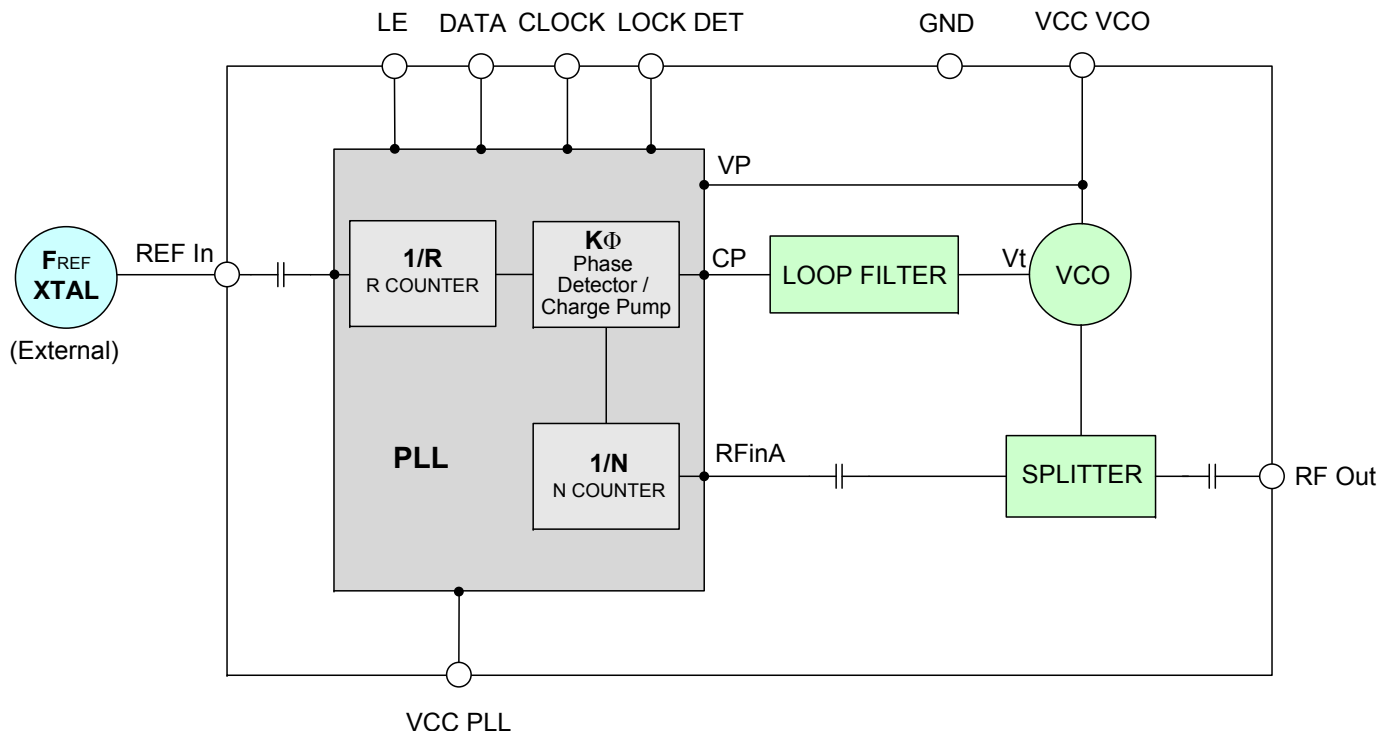

IF/RF MICROWAVE COMPONENTS • ISO 9001 ISO 14001 AS9100 CERTIFIED RoHS compliant
P.O. Box 350166, Brooklyn, New York 11235-0003 (718) 934-4500 Fax (718) 332-4661



The Design Engineers Search Engine finds the model you need, Instantly • For detailed performance specs & shopping online see



Notes: 1. Performance and quality attributes and conditions not expressly stated in this specification sheet are intended to be excluded and do not form a part of this specification sheet. 2. Electrical specifications and performance data contained herein are based on Mini-Circuit's applicable established test performance criteria and measurement instructions. 3. The parts covered by this specification sheet are subject to Mini-Circuits standard limited warranty and terms and conditions (collectively, "Standard Terms"); Purchasers of this part are entitled to the rights and benefits contained therein. For a full statement of the Standard Terms and the exclusive rights and remedies thereunder, please visit Mini-Circuits' website at www.minicircuits.com/MCLStore/terms.jsp.

Electrical Specifications (over operating temperature -40°C to +85°C)

Parameters	Test Conditions	Min.	Typ.	Max.	Units
Frequency Range	-	856.6	-	858.6	MHz
Step Size	-	-	5	-	kHz
Settling Time	Within ± 1 kHz	-	20	-	mSec
Output Power	-	0	+3	+6	dBm
SSB Phase Noise	@ 100 Hz offset	-	-52	-	dBc/Hz
	@ 1 kHz offset	-	-78	-73	
	@ 10 kHz offset	-	-101	-92	
	@ 100 kHz offset	-	-125	-120	
	@ 1 MHz offset	-	-145	-140	
Reference Spurious Suppression	Ref. Freq. 10 MHz	-	-113	-90	dBc
Comparison Spurious Suppression	Step Size 5 kHz	-	-72	-45	
Non - Harmonic Spurious Suppression	-	-	-90	-	
Harmonic Suppression	-	-	-26	-20	
VCO Supply Voltage	5.00	4.75	5.00	5.25	
PLL Supply Voltage	3.30	3.15	3.30	3.45	V
VCO Supply Current	-	-	31	38	mA
PLL Supply Current	-	-	10	17	
Reference Input (External)	Frequency	10 (square wave)	-	10	MHz
	Amplitude	1	-	1	V _{P-P}
	Input impedance	-	-	100	KΩ
	Phase Noise @ 1 kHz offset	-	-	-145	dBc/Hz
RF Output port Impedance	-	-	50	-	Ω
Input Logic Level	Input high voltage	-	2.80	-	V
	Input low voltage	-	-	0.60	V
Digital Lock Detect	Locked	-	2.75	3.45	V
	Unlocked	-	-	0.40	V
Frequency Synthesizer PLL	-	ADF4113			
PLL Programming	-	3-wire serial 3.3V CMOS			
Register Map @ 858.6 MHz	F_Register	-	(MSB) 100111111000000010010011 (LSB)		
	N_Register	-	(MSB) 001101001111011000100001 (LSB)		
	R_Register	-	(MSB) 000100000001111101000000 (LSB)		

Absolute Maximum Ratings

Parameters	Ratings
VCO Supply Voltage	5.6V
PLL Supply Voltage	5.6V
VCO Supply Voltage to PLL Supply Voltage	-0.3V to +5.5V
Reference Frequency Voltage	-0.3Vmin, VCC PLL +0.3Vmax
Data, Clock, LE Levels	-0.3Vmin, VCC PLL +0.3Vmax
Operating Temperature	-40°C to +85°C
Storage Temperature	-55°C to +100°C

Permanent damage may occur if any of these limits are exceeded



IF/RF MICROWAVE COMPONENTS • ISO 9001 ISO 14001 AS9100 CERTIFIED RoHS compliant
 P.O. Box 350166, Brooklyn, New York 11235-0003 (718) 934-4500 Fax (718) 332-4661

The Design Engineers Search Engine finds the model you need, Instantly • For detailed performance specs & shopping online see minicircuits.com

Notes: 1. Performance and quality attributes and conditions not expressly stated in this specification sheet are intended to be excluded and do not form a part of this specification sheet. 2. Electrical specifications and performance data contained herein are based on Mini-Circuit's applicable established test performance criteria and measurement instructions. 3. The parts covered by this specification sheet are subject to Mini-Circuits standard limited warranty and terms and conditions (collectively, "Standard Terms"); Purchasers of this part are entitled to the rights and benefits contained therein. For a full statement of the Standard Terms and the exclusive rights and remedies thereunder, please visit Mini-Circuits' website at www.minicircuits.com/MCLStore/terms.jsp.

Typical Performance Data

FREQUENCY (MHz)	POWER OUTPUT (dBm)			VCO CURRENT (mA)			PLL CURENT (mA)		
	-45°C	+25°C	+85°C	-45°C	+25°C	+85°C	-45°C	+25°C	+85°C
	856.6	3.62	3.84	3.77	29.25	31.34	32.90	7.85	9.98
857.0	3.61	3.84	3.77	29.25	31.34	32.90	7.85	9.98	11.96
857.6	3.61	3.83	3.77	29.24	31.34	32.90	7.85	9.99	11.97
858.0	3.60	3.83	3.77	29.24	31.34	32.90	7.85	9.99	11.97
858.6	3.60	3.83	3.77	29.24	31.34	32.90	7.85	9.99	11.97

FREQUENCY (MHz)	HARMONICS (dBc)					
	F2			F3		
	-45°C	+25°C	+85°C	-45°C	+25°C	+85°C
856.6	-23.99	-25.79	-28.09	-35.36	-37.37	-39.97
857.0	-24.02	-25.83	-28.14	-35.33	-37.38	-40.01
857.6	-24.08	-25.88	-28.18	-35.31	-37.37	-40.02
858.0	-24.12	-25.92	-28.21	-35.29	-37.36	-40.02
858.6	-24.21	-25.99	-28.29	-35.25	-37.31	-39.99

FREQUENCY (MHz)	PHASE NOISE (dBc/Hz) @OFFSETS				
	+25°C				
	100Hz	1kHz	10kHz	100kHz	1MHz
856.6	-49.89	-79.20	-102.34	-124.71	-145.07
857.0	-51.94	-79.33	-102.03	-124.56	-144.77
857.6	-47.92	-78.89	-101.58	-124.60	-144.91
858.0	-51.85	-78.76	-101.28	-124.51	-144.84
858.6	-50.78	-78.09	-101.16	-124.56	-144.85

FREQUENCY (MHz)	PHASE NOISE (dBc/Hz) @OFFSETS				
	-45°C				
	100Hz	1kHz	10kHz	100kHz	1MHz
856.6	-53.98	-78.26	-98.27	-125.40	-145.56
857.0	-53.65	-78.21	-98.53	-125.22	-145.38
857.6	-54.68	-78.77	-98.23	-125.58	-145.48
858.0	-56.10	-77.89	-98.80	-125.37	-145.69
858.6	-57.33	-79.49	-98.98	-125.33	-145.68

FREQUENCY (MHz)	PHASE NOISE (dBc/Hz) @OFFSETS				
	+85°C				
	100Hz	1kHz	10kHz	100kHz	1MHz
856.6	-50.33	-77.22	-95.16	-123.47	-143.73
857.0	-49.64	-77.33	-96.52	-123.55	-143.59
857.6	-49.43	-77.14	-97.07	-123.49	-143.70
858.0	-51.87	-78.09	-96.88	-123.47	-143.74
858.6	-51.04	-76.60	-96.99	-123.66	-143.77



IF/RF MICROWAVE COMPONENTS • ISO 9001 ISO 14001 AS9100 CERTIFIED RoHS compliant
 P.O. Box 350166, Brooklyn, New York 11235-0003 (718) 934-4500 Fax (718) 332-4661



The Design Engineers Search Engine finds the model you need, Instantly • For detailed performance specs & shopping online see



Notes: 1. Performance and quality attributes and conditions not expressly stated in this specification sheet are intended to be excluded and do not form a part of this specification sheet. 2. Electrical specifications and performance data contained herein are based on Mini-Circuit's applicable established test performance criteria and measurement instructions. 3. The parts covered by this specification sheet are subject to Mini-Circuits standard limited warranty and terms and conditions (collectively, "Standard Terms"); Purchasers of this part are entitled to the rights and benefits contained therein. For a full statement of the Standard Terms and the exclusive rights and remedies thereunder, please visit Mini-Circuits' website at www.minicircuits.com/MCLStore/terms.jsp.

COMPARISON SPURIOUS ORDER	COMPARISON SPURIOUS @Fcarrier 856.6MHz+(n*Fcomparison) (dBc) note 1			COMPARISON SPURIOUS @Fcarrier 857.6MHz+(n*Fcomparison) (dBc) note 1			COMPARISON SPURIOUS @Fcarrier 858.6MHz+(n*Fcomparison) (dBc) note 1		
	-45°C	+25°C	+85°C	-45°C	+25°C	+85°C	-45°C	+25°C	+85°C
n									
-5	-84.36	-85.04	-82.66	-83.49	-84.46	-86.85	-83.00	-83.76	-87.23
-4	-81.74	-82.73	-80.99	-80.54	-82.50	-83.56	-82.54	-82.22	-82.15
-3	-79.78	-79.59	-75.35	-78.18	-80.83	-78.31	-79.29	-79.51	-78.33
-2	-74.62	-76.12	-68.18	-73.05	-76.84	-71.71	-76.16	-75.39	-72.23
-1	-63.72	-75.02	-50.25	-68.36	-71.97	-53.32	-63.72	-69.56	-54.08
0 note 2	-	-	-	-	-	-	-	-	-
+1	-64.41	-69.46	-50.52	-70.22	-69.42	-52.40	-70.50	-69.85	-53.81
+2	-73.84	-76.81	-68.83	-73.02	-75.88	-70.30	-73.79	-73.70	-72.24
+3	-79.88	-79.82	-75.17	-79.40	-80.63	-78.36	-79.46	-79.63	-78.77
+4	-82.40	-81.42	-80.57	-81.12	-82.96	-85.99	-80.91	-83.07	-84.25
+5	-84.77	-84.24	-85.64	-82.43	-83.09	-87.50	-83.83	-84.43	-88.86

Note 1: Comparison frequency 5 kHz
 Note 2: All spurs are referenced to carrier signal (n=0).

REFERENCE SPURIOUS ORDER	REFERENCE SPURIOUS @Fcarrier 856.6MHz+(n*Freference) (dBc) note 3			REFERENCE SPURIOUS @Fcarrier 857.6MHz+(n*Freference) (dBc) note 3			REFERENCE SPURIOUS @Fcarrier 858.6MHz+(n*Freference) (dBc) note 3		
	-45°C	+25°C	+85°C	-45°C	+25°C	+85°C	-45°C	+25°C	+85°C
n									
-5	-126.65	-126.95	-127.08	-126.75	-126.67	-128.92	-127.06	-125.91	-129.61
-4	-128.02	-126.24	-130.72	-127.10	-131.13	-131.57	-129.52	-129.77	-131.56
-3	-121.61	-119.33	-122.73	-120.68	-120.04	-121.75	-120.65	-120.00	-121.09
-2	-131.28	-129.88	-131.12	-131.86	-128.79	-131.95	-130.98	-129.80	-130.93
-1	-114.40	-112.51	-112.80	-114.95	-113.25	-115.51	-114.69	-113.36	-112.14
0 note 4	-	-	-	-	-	-	-	-	-
+1	-113.89	-113.86	-112.24	-114.75	-115.06	-113.91	-115.62	-113.73	-111.84
+2	-130.13	-130.74	-130.95	-131.65	-132.03	-130.68	-130.46	-131.54	-131.74
+3	-124.85	-123.94	-124.55	-126.66	-124.33	-126.50	-125.80	-123.55	-123.83
+4	-131.37	-127.09	-132.12	-130.60	-131.12	-131.28	-130.41	-129.18	-129.66
+5	-127.55	-125.25	-125.37	-124.64	-126.02	-130.15	-128.67	-125.73	-126.39

Note 3: Reference frequency 10 MHz
 Note 4: All spurs are referenced to carrier signal (n=0).



IF/RF MICROWAVE COMPONENTS • ISO 9001 ISO 14001 AS9100 CERTIFIED RoHS compliant
 P.O. Box 350166, Brooklyn, New York 11235-0003 (718) 934-4500 Fax (718) 332-4661



The Design Engineers Search Engine finds the model you need, Instantly • For detailed performance specs & shopping online see



Notes: 1. Performance and quality attributes and conditions not expressly stated in this specification sheet are intended to be excluded and do not form a part of this specification sheet. 2. Electrical specifications and performance data contained herein are based on Mini-Circuit's applicable established test performance criteria and measurement instructions. 3. The parts covered by this specification sheet are subject to Mini-Circuits standard limited warranty and terms and conditions (collectively, "Standard Terms"); Purchasers of this part are entitled to the rights and benefits contained therein. For a full statement of the Standard Terms and the exclusive rights and remedies thereunder, please visit Mini-Circuits' website at www.minicircuits.com/MCLStore/terms.jsp.

Typical Performance Curves

OUTPUT POWER Vs FREQUENCY

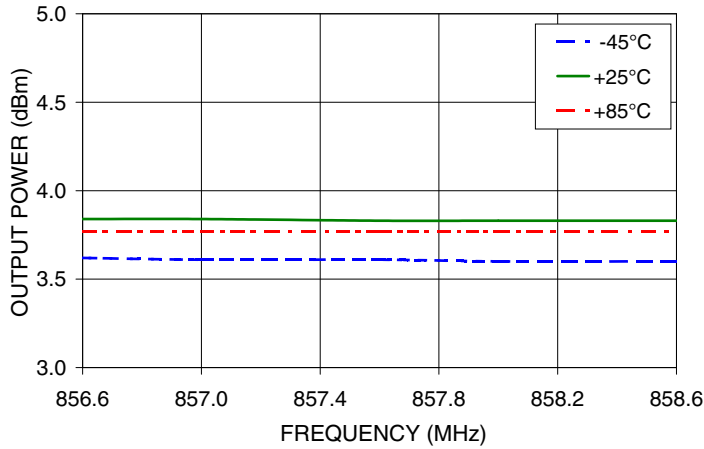

2nd HARMONIC Vs FREQUENCY

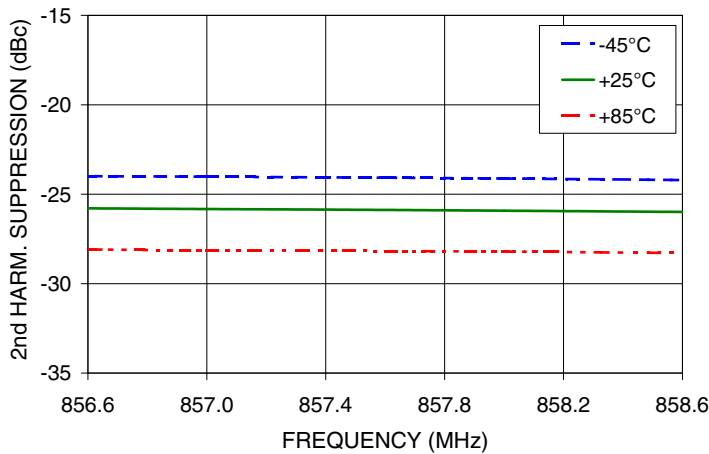

3rd HARMONIC Vs FREQUENCY

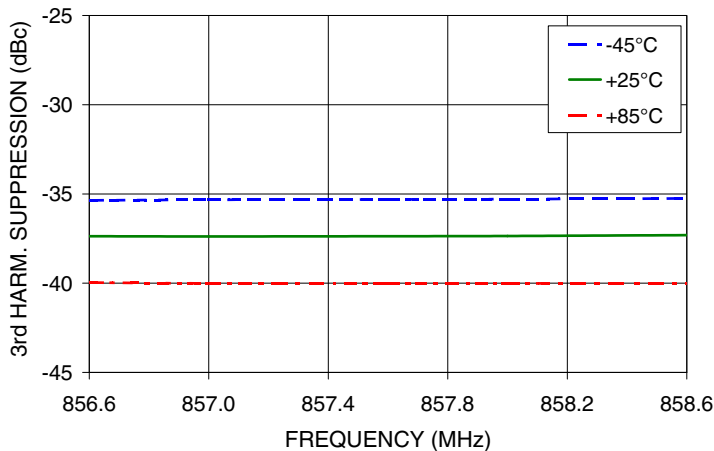

IF/RF MICROWAVE COMPONENTS • ISO 9001 ISO 14001 AS9100 CERTIFIED RoHS compliant
 P.O. Box 350166, Brooklyn, New York 11235-0003 (718) 934-4500 Fax (718) 332-4661



The Design Engineers Search Engine finds the model you need, Instantly • For detailed performance specs & shopping online see



Notes: 1. Performance and quality attributes and conditions not expressly stated in this specification sheet are intended to be excluded and do not form a part of this specification sheet. 2. Electrical specifications and performance data contained herein are based on Mini-Circuit's applicable established test performance criteria and measurement instructions. 3. The parts covered by this specification sheet are subject to Mini-Circuits standard limited warranty and terms and conditions (collectively, "Standard Terms"); Purchasers of this part are entitled to the rights and benefits contained therein. For a full statement of the Standard Terms and the exclusive rights and remedies thereunder, please visit Mini-Circuits' website at www.minicircuits.com/MCLStore/terms.jsp.

PHASE NOISE @100Hz offset

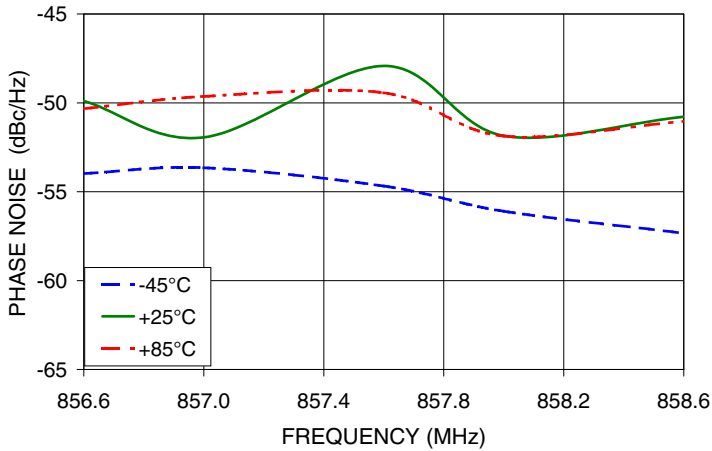

PHASE NOISE @1kHz offset

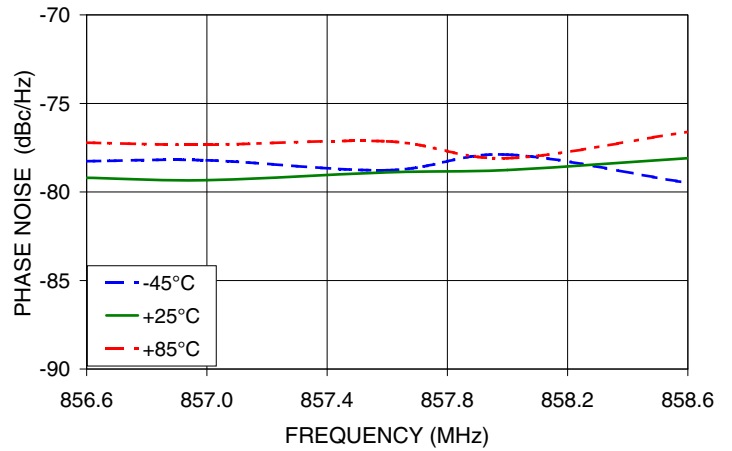

PHASE NOISE @10 kHz offset

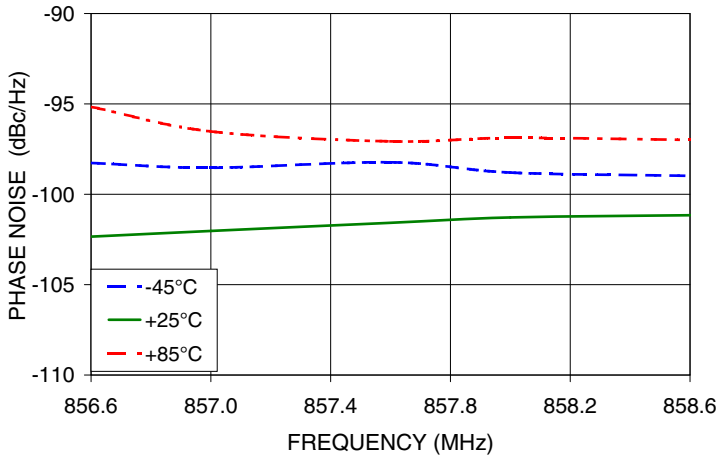

PHASE NOISE @100 kHz offset

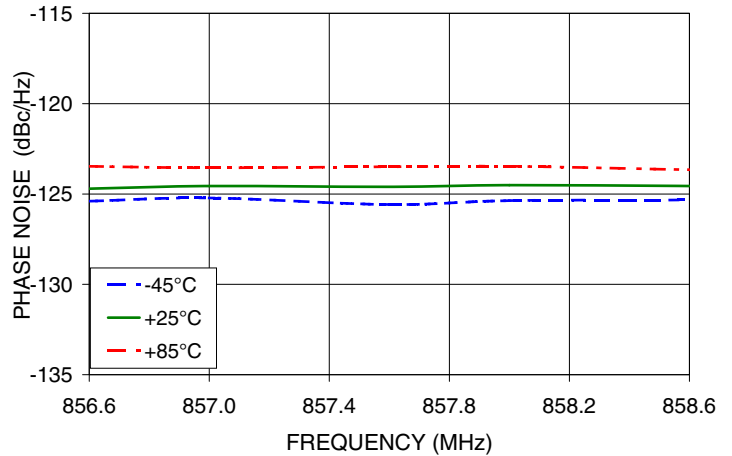

PHASE NOISE @1MHz offset

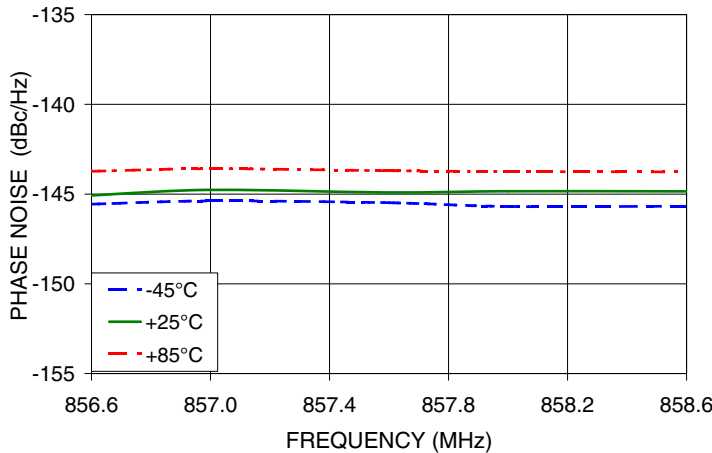

IF/RF MICROWAVE COMPONENTS • ISO 9001 ISO 14001 AS9100 CERTIFIED RoHS compliant
 P.O. Box 350166, Brooklyn, New York 11235-0003 (718) 934-4500 Fax (718) 332-4661



The Design Engineers Search Engine finds the model you need, Instantly • For detailed performance specs & shopping online see



Notes: 1. Performance and quality attributes and conditions not expressly stated in this specification sheet are intended to be excluded and do not form a part of this specification sheet. 2. Electrical specifications and performance data contained herein are based on Mini-Circuit's applicable established test performance criteria and measurement instructions. 3. The parts covered by this specification sheet are subject to Mini-Circuits standard limited warranty and terms and conditions (collectively, "Standard Terms"); Purchasers of this part are entitled to the rights and benefits contained therein. For a full statement of the Standard Terms and the exclusive rights and remedies thereunder, please visit Mini-Circuits' website at www.minicircuits.com/MCLStore/terms.jsp.

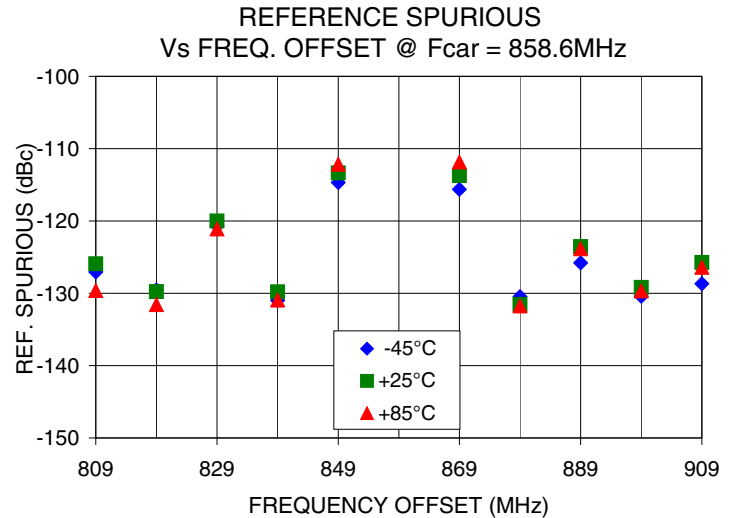
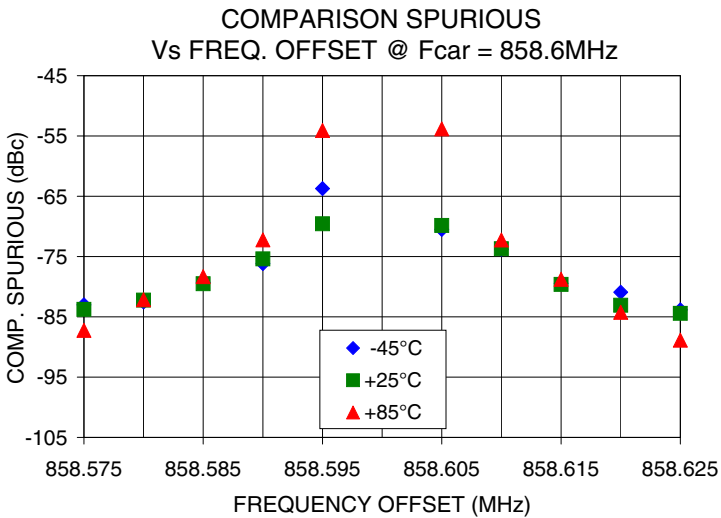
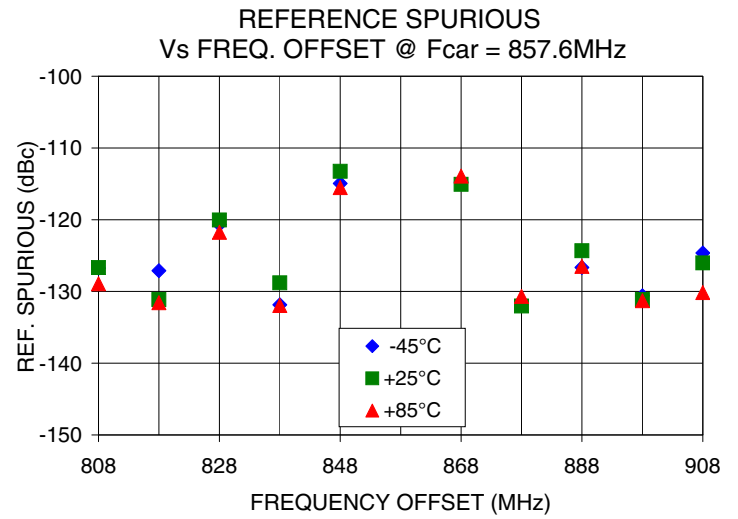
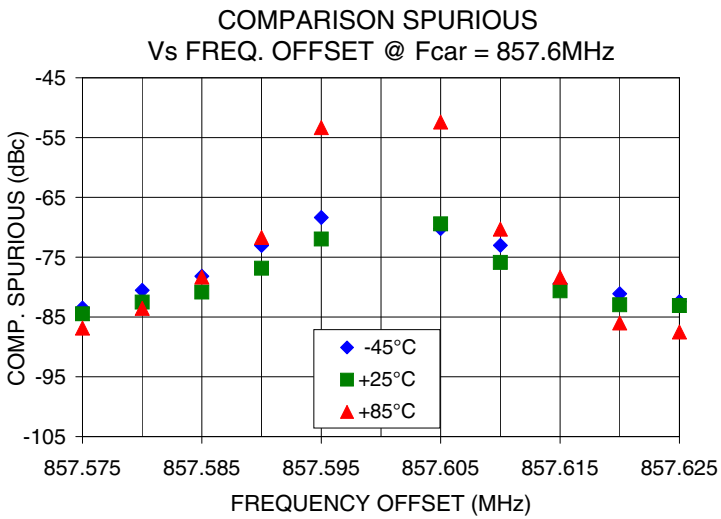
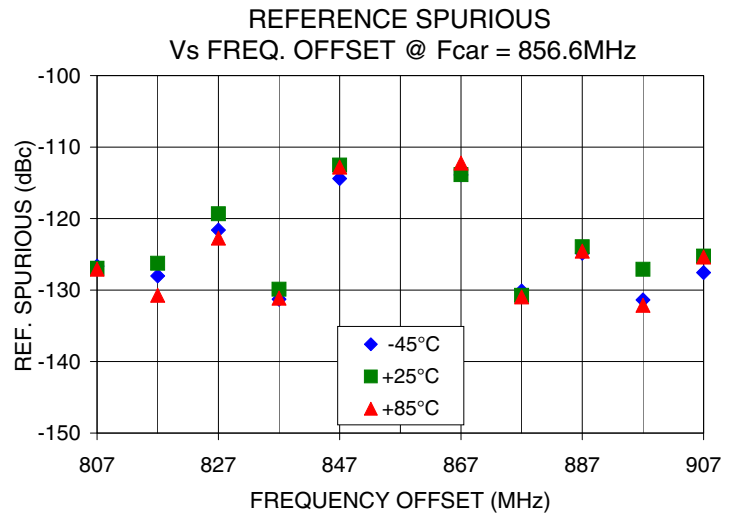
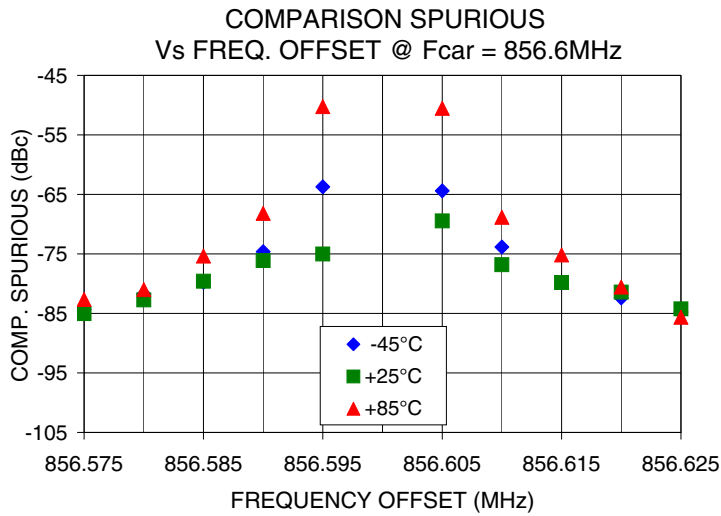

IF/RF MICROWAVE COMPONENTS • ISO 9001 ISO 14001 AS9100 CERTIFIED RoHS compliant
P.O. Box 350166, Brooklyn, New York 11235-0003 (718) 934-4500 Fax (718) 332-4661



The Design Engineers Search Engine finds the model you need, Instantly • For detailed performance specs & shopping online see



Notes: 1. Performance and quality attributes and conditions not expressly stated in this specification sheet are intended to be excluded and do not form a part of this specification sheet. 2. Electrical specifications and performance data contained herein are based on Mini-Circuit's applicable established test performance criteria and measurement instructions. 3. The parts covered by this specification sheet are subject to Mini-Circuits standard limited warranty and terms and conditions (collectively, "Standard Terms"); Purchasers of this part are entitled to the rights and benefits contained therein. For a full statement of the Standard Terms and the exclusive rights and remedies thereunder, please visit Mini-Circuits' website at www.minicircuits.com/MCLStore/terms.jsp.

Pin Configuration

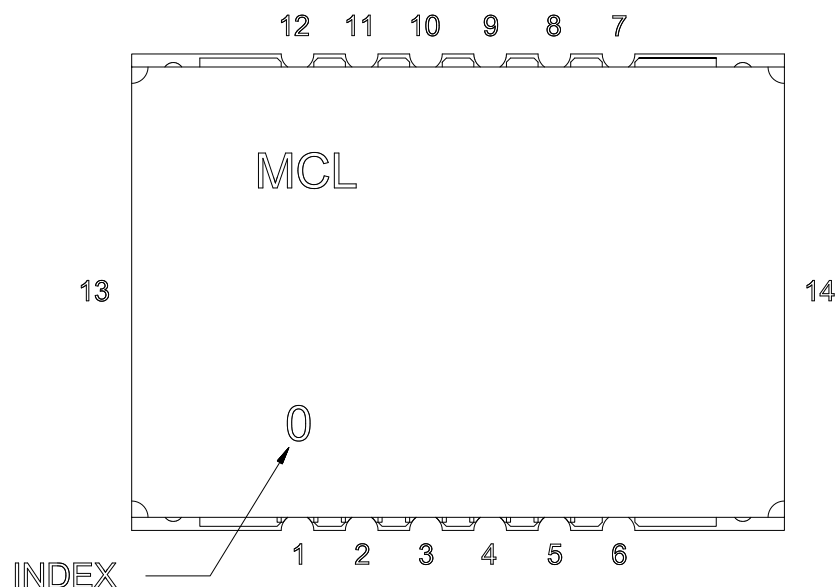

Pin Connection

Pin Number	Function
1	VCC PLL
2	GND
3	REF IN
4	GND
5	VCC VCO
6	GND
7	RF OUT
8	GND
9	LOCK DET
10	CLOCK
11	DATA
12	LE
13	GND
14	GND

Recommended Application Circuit

Note: REF IN and RF OUT ports are internally AC coupled.

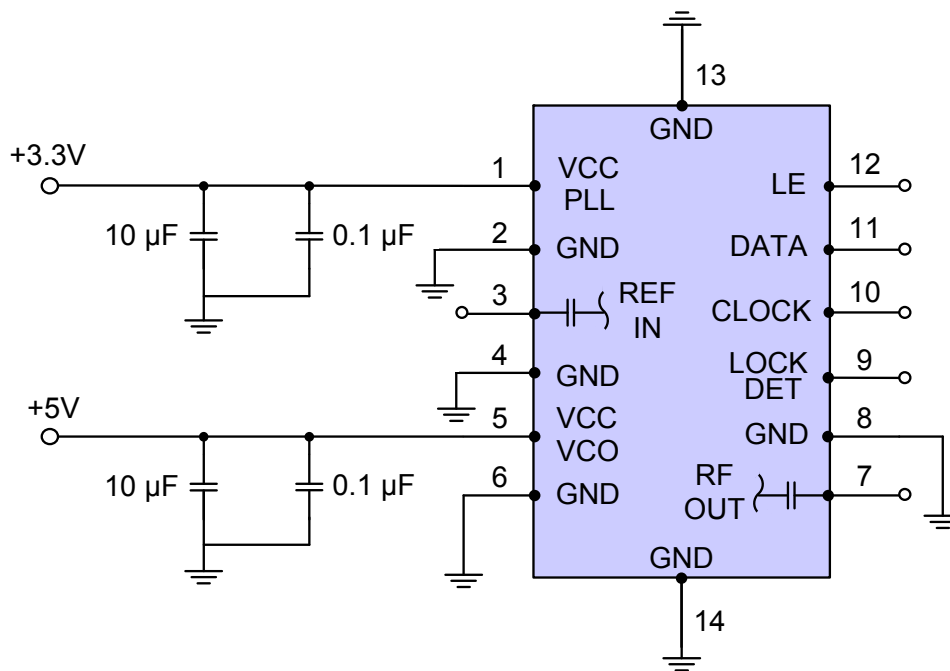

IF/RF MICROWAVE COMPONENTS • ISO 9001 ISO 14001 AS9100 CERTIFIED RoHS compliant
 P.O. Box 350166, Brooklyn, New York 11235-0003 (718) 934-4500 Fax (718) 332-4661



The Design Engineers Search Engine finds the model you need, Instantly • For detailed performance specs & shopping online see



Notes: 1. Performance and quality attributes and conditions not expressly stated in this specification sheet are intended to be excluded and do not form a part of this specification sheet. 2. Electrical specifications and performance data contained herein are based on Mini-Circuit's applicable established test performance criteria and measurement instructions. 3. The parts covered by this specification sheet are subject to Mini-Circuits standard limited warranty and terms and conditions (collectively, "Standard Terms"); Purchasers of this part are entitled to the rights and benefits contained therein. For a full statement of the Standard Terms and the exclusive rights and remedies thereunder, please visit Mini-Circuits' website at www.minicircuits.com/MCLStore/terms.jsp.

Device Marking

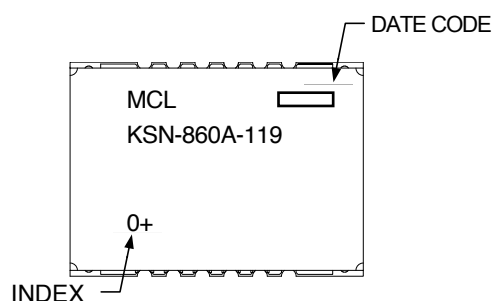

Additional Detailed Technical Information

Additional information is available on our web site. To access this information enter the model number on our web site home page.

Case Style: DK801

Tape & Reel: TR-F28

Suggested Layout for PCB Design: PL-249

Evaluation Board: TB-567-1+

Environment Ratings: ENV03T2



IF/RF MICROWAVE COMPONENTS • ISO 9001 ISO 14001 AS9100 CERTIFIED RoHS compliant
P.O. Box 350166, Brooklyn, New York 11235-0003 (718) 934-4500 Fax (718) 332-4661



The Design Engineers Search Engine finds the model you need, Instantly • For detailed performance specs & shopping online see



Notes: 1. Performance and quality attributes and conditions not expressly stated in this specification sheet are intended to be excluded and do not form a part of this specification sheet. 2. Electrical specifications and performance data contained herein are based on Mini-Circuit's applicable established test performance criteria and measurement instructions. 3. The parts covered by this specification sheet are subject to Mini-Circuits standard limited warranty and terms and conditions (collectively, "Standard Terms"); Purchasers of this part are entitled to the rights and benefits contained therein. For a full statement of the Standard Terms and the exclusive rights and remedies thereunder, please visit Mini-Circuits' website at www.minicircuits.com/MCLStore/terms.jsp.